

Article number: 12318000120160
Description: KLEE-coil 318 000 120.160
M12 Hardened/zinc-plated slotted pin

Measures

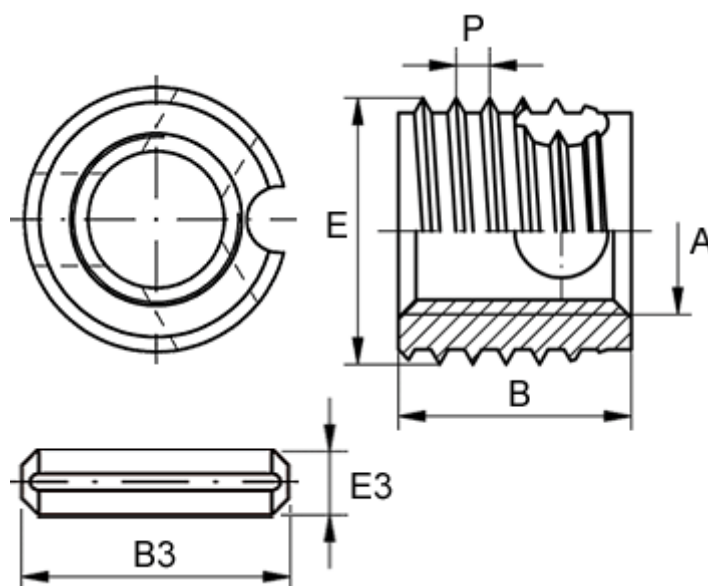

Female thread A	= M12
Length B	= 22
Male thread E	= 16.0
Min hole depth blind hole	= 26
Slotted pin B3	= 16
Slotted pin E3	= 2
Thread pitch P	= 1.75
Type	= 318 000 120 ...